



# Light Bar Bumper Kit Club Car Precedent

All Models 2004+ Gas & Electric

## Installation Instructions



### Tools Needed for Installation

- Screwdrivers (Phillips & Flat Head)
- Sockets & Open Ended Wrenches (10mm, 7/16", 13mm)
- Torx Bits (T-15, T-30, T-40)
- Drill, Drill Bits & Hole Saws (1/8", 3/16", 7/16", 1", 1-1/2")
- Wire Cutters
- Wire Crimpers
- Wire Snake, Fish Tape or Wire Coat Hanger
- Utility Knife
- Hammer

**Caution:** Please read through the instructions carefully. Before starting this project, remove the system's positive and negative connections from the battery or battery pack. This kit is designed for a 12V operation only. Operating this kit at a higher voltage will void any and all warranties. Look behind each drill location BEFORE YOU DRILL. Installer is responsible for damage (i.e. drilling into a wiring harness, battery, fuel tank etc.).

Table of Contents

1) **Headlight and Taillight Preparation** ..... Page 3

2) **Wiring Harness Installation**..... Page 4

LGT-306H Gas Harness (Gas Carts Only)

LGT-396 Bucket Harness

LGT-696 Plug & Play Harness

VOLT-0010A Voltage Reducer (8V Batteries)

VOLT-0011B Voltage Reducer Sub-Harness (8V Batteries)

3) **Headlight Bumper** ..... Page 9

LGT-306E Light Bar Bumper, Halogen Bulbs

LGT-306EL Light Bar Bumper, LED Bulbs

4) **Taillights** ..... Page 10

LGT-306E/EL Taillights

5) **Power Connections** ..... Page 10

Optional Accessory Instructions

1) **Turn Signal Assemblies** ..... Page 14

LGT-107A Universal Turn Signal Switch Wire Cover

LGT-112 Turn Signal Switch w/ Horn Button

LGT-132A Turn Signal Switch w/ Horn Button

LGT-143 Turn Signal Switch

2) **Horn Kits** ..... Page 15

ACC-0004 Horn, 12 Volt, 2-Terminal

ACC-0077 Horn Kit, Floor Mount

3) **12 Volt Receptacle and Dual USB Outlet** ..... Page 16

ACC-0058 12 Volt Outlet

ACC-0088 USB Dual Port Charging Receptacle

4) **Brake Light Switches** ..... Page 18

LGT-136 Brake Pad Switch Sub-Harness

LGT-138 Brake Pad Switch

LGT-644 Brake Light Switch w/ Time Delay

**This kit is designed for a 12 Volt operation ONLY.  
Operating this kit at a higher voltage will damage the  
lights and accessories and void all warranties.**

## Before You Start

1. Turn the key to the OFF position.
2. Place the TOW/RUN switch in the TOW position (electric carts).
3. Remove the system's positive and negative connections from the battery or battery pack.
4. Engage the parking brake.

### Headlight and Taillight Preparation



LGT-306E/EL



LGT-306E



LGT-306EL

1. Remove the front bumper by removing the two mounting bolts. Discard bumper, it will not be reused. Retain all mounting hardware.



2. On the driver side rear body, measure 2-1/4" over from the vertical body line and 1-1/2" up from the underbody. Mark this location with a center punch. Drill the location with a 1-1/2" hole saw. Sand hole to remove rough edges.

Repeat Step 2 for passenger side.



3. Electric carts 2004-2008.5 and gas carts: reach inside the holes of the rear body and pull the taillight connectors through the holes.

Electric carts 2008.5+: install the LGT-396 bucket harness (page 5).

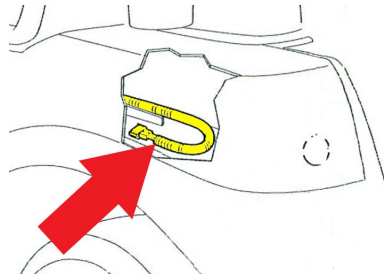

# Wiring Harness Overview

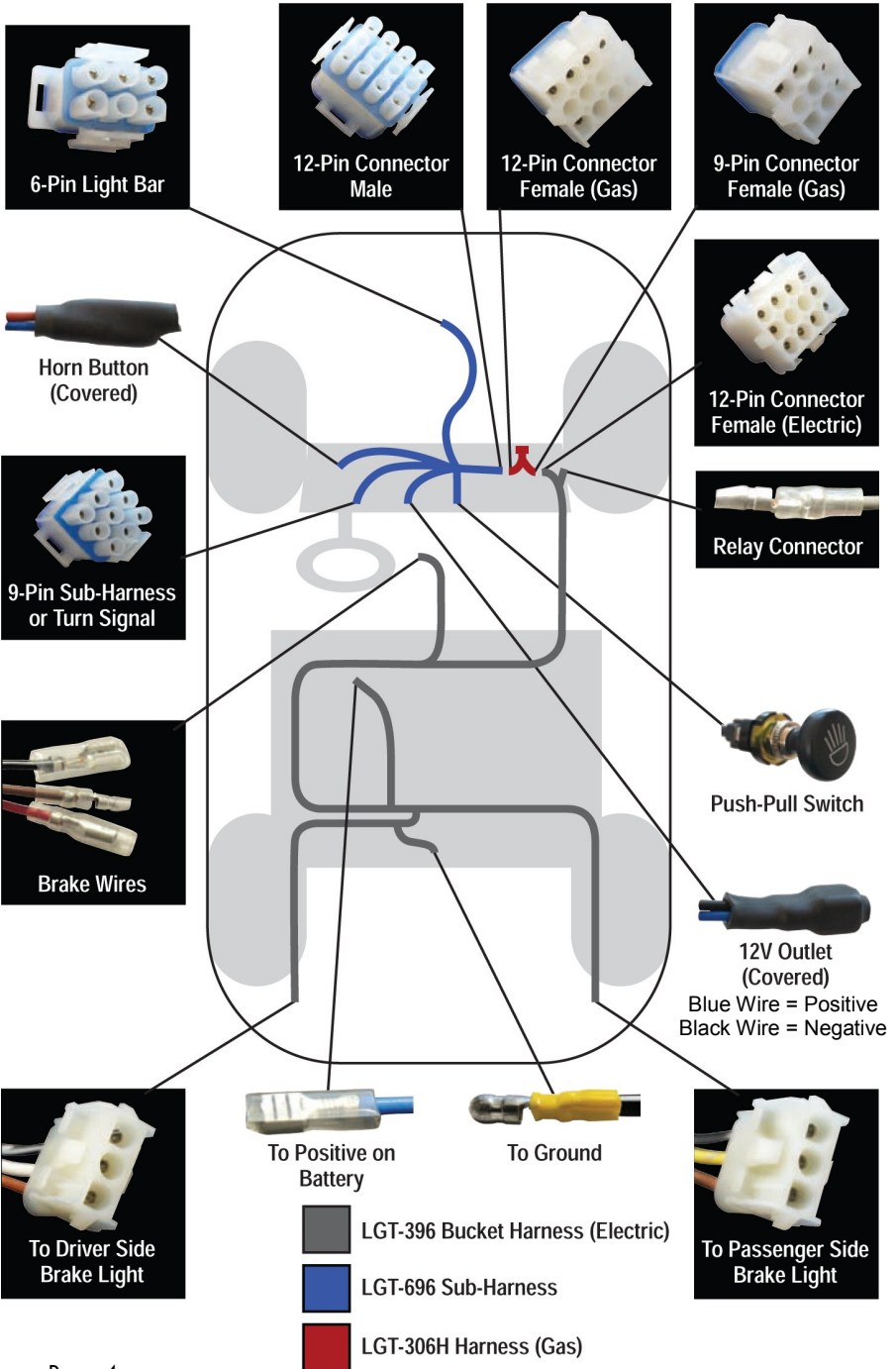

## Wiring Harnesses



LGT-306H (Gas Only)



LGT-396



LGT-696



VOLT-0010A



VOLT-0011B

### Electric Carts 2004-2008.5

1. Remove the dash panel by removing the Torx bolts and retain hardware.



2. Locate the factory 12-pin male connector behind the dash and connect it to the 12-pin connector on the LGT-696 sub-harness.

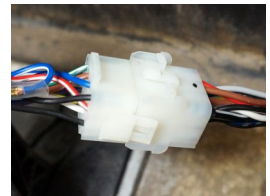

**CONTINUE TO LGT-696 SECTION (PAGE 9)**

### Electric Carts 2008.5+ (Photos show 8 Volt Battery Configuration)

**Note:** Electric Club Car Precedents manufactured after the mid 2008s require an additional bucket harness (LGT-396) to allow the installation of light kits. The harness can be used for an 8V or 12V battery configuration. A voltage reducer is required for use with 8V batteries.

1. Completely remove the front seat bottom assembly.
2. Loosen the (4) Torx screws that secure the floor mat and retainer rocker panels to the vehicle. Lift out mat and retain hardware.



3. Remove the rivet on the pedal group access panel and remove the panel. Retain hardware.

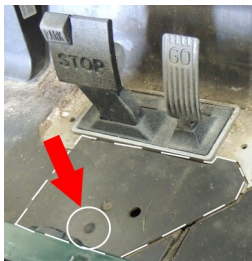

4. Remove and retain the front body screws.
5. Using a small screwdriver, pry the charging receptacle cover from the vehicle. Retain cover.

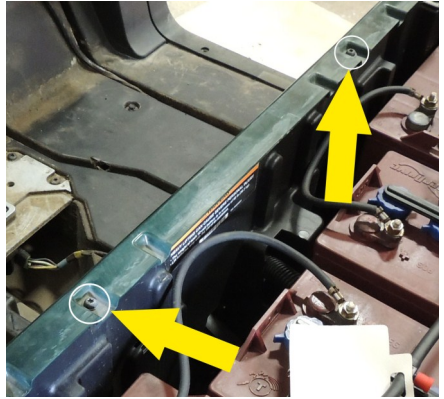

6. Remove and retain the (3) screws that secure the lower body trim to the body. Lift off the lower body trim. Use caution not to brake the tabs on the trim when removing it.

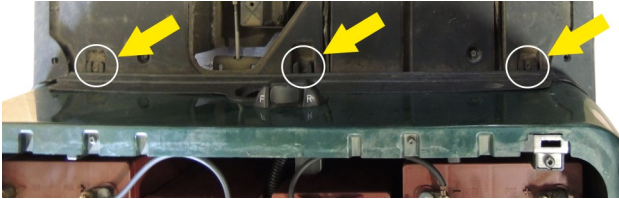

7. Feed the 12-pin connector and brake light wires on the LGT-396 harness from the battery compartment through the through-hole where the main harness runs to the front of the cart (below the F/R switch location).



8. Feed the brake light wires through the center floor channel into the pedal group compartment. Use cable ties to secure them to the existing harness.

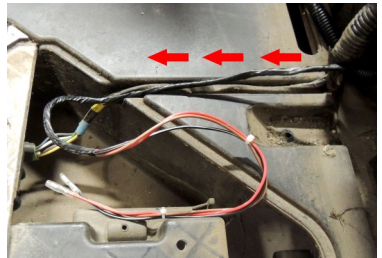

- Remove the dash panel by removing the Torx screws. Retain hardware.



- Feed the 12-pin connector along the floor channel with the main harness (on the passenger side) and up under the dash. Secure with cable ties.

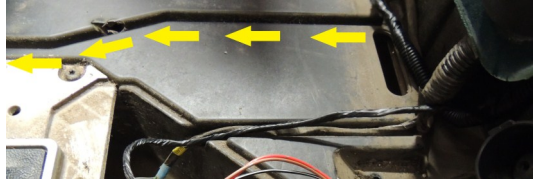

- Connect the male bullet connector on the LGT-396 to the red female bullet connector on the factory harness.

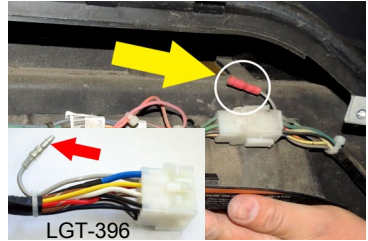

- Carts with 12 Volt battery configurations, connect the 12-pin connector on the LGT-396 to the 12-pin connector on the LGT-696 sub-harness. Continue to step 16.

Carts with 8 Volt battery configurations, connect the 12-pin connector on the LGT-396 to the 12-pin connector on the VOLT-0011B voltage reducer sub-harness. Connect the second 12-pin connector on VOLT-0011B to the 12-pin connector on the LGT-696 sub-harness.

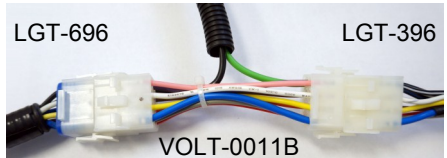

- Route the gray connector on the VOLT-0011B through the access hole (on the passenger side dash) to the underside of the cart.

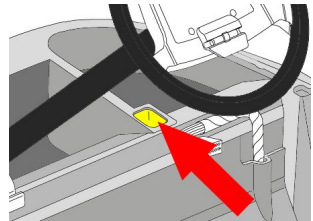

- From beneath the vehicle, install the VOLT-0010A voltage reducer with the Included Hardware on the center dash support.

- Connect the gray male connector on the VOLT-0010A to the gray female connector on the VOLT-0011B.

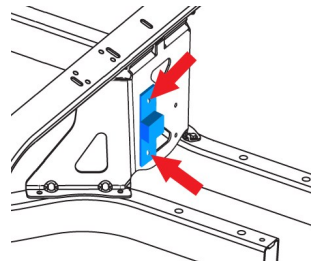

Front Frame of Cart





- From beneath the vehicle, install the voltage regulator with the Included Hardware on the rear side of the center dash support.
- Reconnect the green and black wires to their original locations on the voltage regulator.

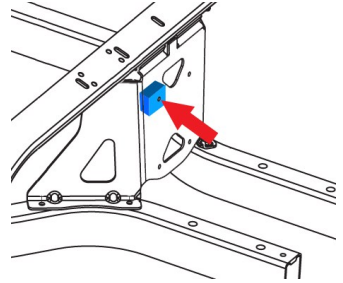

**CONTINUE TO LGT-696 SECTION BELOW**

### LGT-696 Sub-Harness

- Route the 6-pin connector, on the LGT-696 harness, for the light bar through the access hole in the passenger side dash.

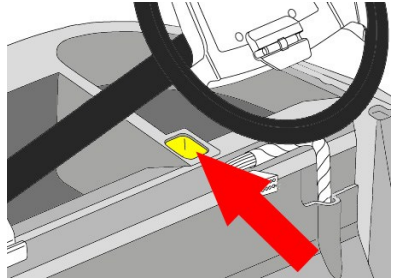

If powering the lights with the push-pull switch included on the LGT-696 sub-harness, locate the indentation to the right of the key switch on the dash panel and drill a 7/16" hole.

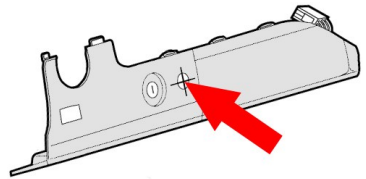

**NOTE:** If installing the LGT-132A turn signal, do not install the push-pull switch.

- Remove the knob, retaining nuts and washer from the push-pull switch and insert the shaft of the switch into the newly drilled hole.
- Secure using the retaining nuts and washer. Reattach knob.



### **Headlight Bumper**



LGT-306E



LGT-306EL

**NOTE:** If installing other accessories, do so before installing the headlight bumper bar.

1. Run the 6-pin connector on the sub-harness around the passenger side of the chassis and under the shock.
2. Connect the 6-pin connector on the LGT-696 to the 6-pin connector on the light bar.

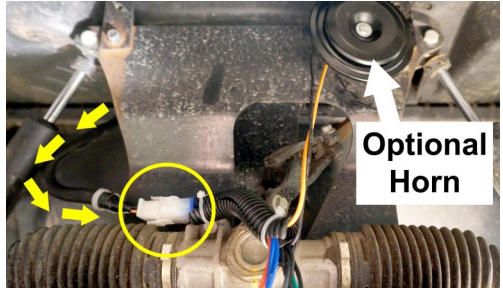

3. Install the headlight bumper using the Original Bumper Mounting Hardware.
4. Reinstall dash panel using Original Hardware.



### Taillights



LGT-306E/EL

1. Connect the taillights to the wire harness that was pulled through the hole in the rear body.
2. Test fit each taillight. They should rest on the underbody and line up with the edge of the bagwell.



**NOTE:** Do not expose double sided tape until lights are functioning and have been test fit.

3. Clean the mounting surface with rubbing alcohol. If the taillights function properly, remove the paper on the double sided tape and mount the taillights on the rear body.
4. Use the Included Screws to further secure the taillights.



### Power Connections



Fuse Harness



Positive Lead



Ground

**NOTE:** Complete this section once all lights and optional accessories have been installed.

The following instructions show the batteries in the factory configurations. Your configuration may vary. Test all batteries with a voltage meter prior to installation to determine the output voltage. **Connecting lights to a voltage higher than 12V will damage the lights and accessories and void all warranties.**

### All Carts

1. Verify the cart is in the TOW position (electric) and the key is in the OFF position.
2. Verify any exposed wires and the push-pull switch are not touching the frame or any metal parts on the cart.

### Electric Carts 2004-2008.5

1. Remove the controller/OBC cover (shown in green below). Retain hardware.
2. Connect the longer side of the fuse harness to the blue lead on battery #4.
3. Under the controller/OBC cover, locate the single 12 gauge blue wire with a female connector on the main harness and connect it to the shorter side of the fuse harness.
4. Secure any loose wires with cable ties.
5. Reinstall controller/OBC cover with Original Hardware.

## 2004-2008.5 Club Car Precedent

**WARNING: 48V CONNECTION**

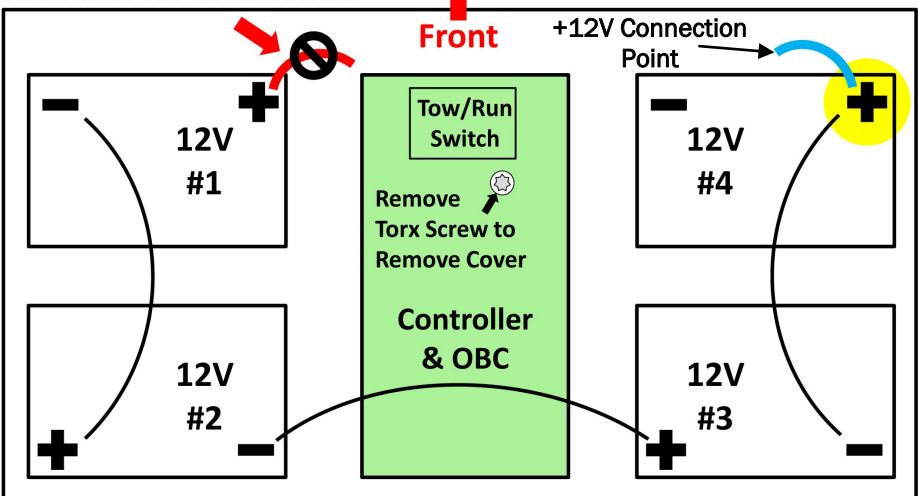

## Electric Carts 2008.5+ w/ 12 Volt Batteries

1. Connect the blue positive lead from the LGT-396 harness to the blue pigtail coming off the negative (-) post on battery #3

**NOTE:** If the factory cables have been replaced, connect the positive lead directly to the negative post on battery #3 with a ring terminal.

**WARNING: DO NOT connect the positive lead to the blue wire on battery #1.** This will connect the lights to a 48V power source and will cause damage. If in doubt as to which battery is correct, test with a voltage reader.

### 2008.5+ Club Car Precedent with 12 Volt Batteries

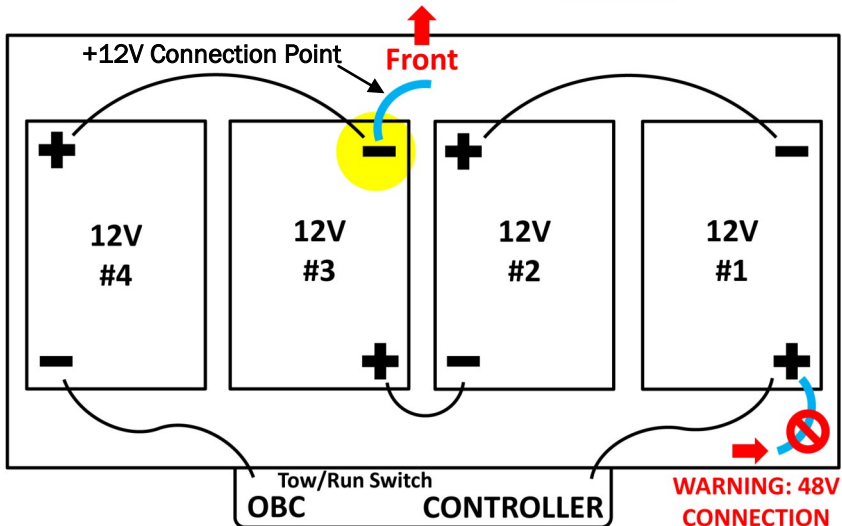

2. Connect the ground (black wire with yellow male bullet connector) on the LGT-396 harness to the ground behind battery #3. The ground will be a 12 gauge black wire with a yellow female bullet connector.

## Electric Carts 2008.5+ w/ 8 Volt Batteries

**NOTE:** This configuration requires the installation of the VOLT-0010A voltage reducer to change the output voltage from 16V to 12V.

1. Connect the blue positive lead from the LGT-396 harness to the blue pigtail coming off the negative (-) post on battery #4.

**NOTE:** If the factory cables have been replaced, connect the positive lead directly to the negative post on battery #4 with a ring terminal.

**WARNING: DO NOT connect the positive lead to the blue wire on battery #1.** This will connect the lights to a 48V power source and will cause damage. If in doubt as to which battery is correct, test with a voltage reader.

2. Connect the ground (yellow male bullet connector) on the LGT-396 harness to the ground behind battery #4. The ground will be a #12 black wire with a yellow female bullet connector.

## 2008.5+ Club Car Precedent with 8 Volt Batteries

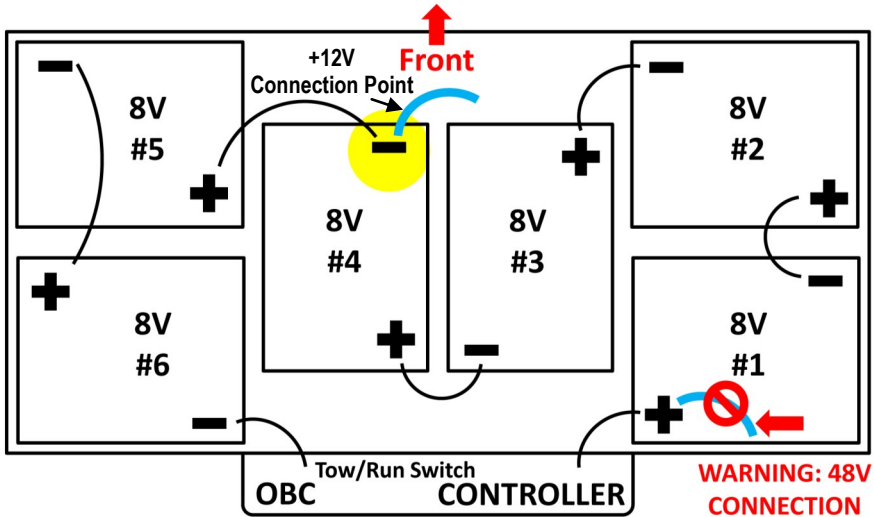

### Gas Carts

1. Remove the extension lead from the fuse harness and discard.
2. Connect (1) wire on the fuse harness to the 12 gauge blue wire coming off of the 12V solenoid.
3. Connect the second wire on the fuse harness to the 12 gauge blue wire coming out of the main harness near the solenoid.
4. Secure all loose wires with cable ties.

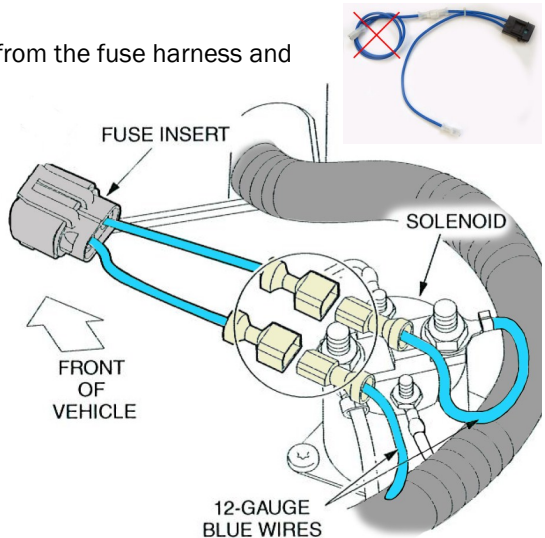

## Turn Signal Assemblies



LGT-107A



LGT-112



LGT-132A



LGT-143

**NOTE:** If installing a steering column cover, do so before installing the turn signal.

1. Mount the turn signal assembly in a convenient location on the steering column using the included hose clamp for the LGT-112 and the LGT-143. Mount the LGT-132A using the included collar and choose one of the included rubber inserts that best fits the diameter of the steering column.



LGT-112

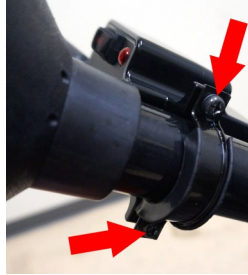

LGT-132A



LGT-143

2. Connect the 9-pin connector on the turn signal switch to the 9-pin connector on the LGT-696 sub-harness.



3. If installing the LGT-132A, remove the push-pull switch at the 4-pin connector and replace it with the LGT-590 relay harness.



4. Connect the included flasher relay to the turn signal switch wire harness.



5. Measure from the turn signal boot to the dash. Using a utility knife, saw or tin snips, cut the LGT-107A, universal turn signal switch wire cover, to length.



6. Snap the cover around the wires of the turn signal switch and the steering column.



## Horns

\* Horn Decal and floor mounted button are not included with the LGT-112 or LGT-132A Turn Signals



### ACC-0004 12 Volt, 2 Terminal Horn

1. Locate the (2) spade connectors on the light bar wire harness and connect them to the back of the horn (it doesn't matter which wire goes to which terminal on the horn).
2. Mount the horn to the chassis using the bolt next to the driver side upper shock mount.

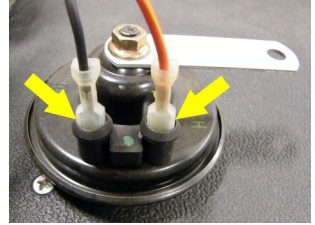

**NOTE:** The side of the horn with the wires will face the rear of the cart.

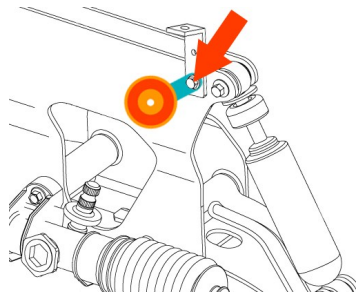

### ACC-0077 Floor Mount Horn Kit

1. Locate a convenient location on the floor mat to mount the horn button. Make sure to avoid clearance issues with the brake pedal, cup holder and side trim.
2. At the top of the location, drill a 1/8" hole through the mat **ONLY**. Do **NOT** drill through the underbody.
3. Thread the horn button's wire through the 1/8" hole. Reach behind the floor mat and pull the wire lead through until the button meets the mat.

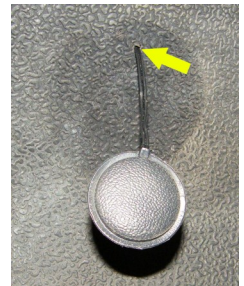
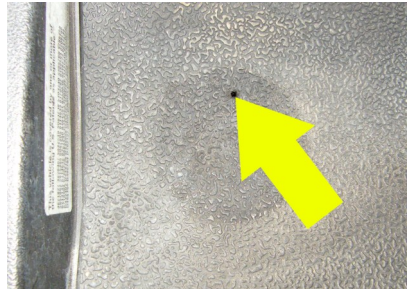

4. Place the horn button decal over the button making sure it is even and the button is centered. Mark the (4) mounting holes. Remove the decal and button. Drill the (4) marked locations with a 3/16" drill bit through the mat ONLY.



5. Thread the horn button's wire through the 1/8" hole, under the mat and up to the dash area. Place the decal over the button. Mount the decal using the Included Rivets.

6. Locate the covered horn button connectors on the LGT-696 sub-harness and carefully remove the cover with a utility knife.



7. Connect the horn button wires to the butt connectors and crimp the connectors to secure (it doesn't matter which wire goes to which connector).

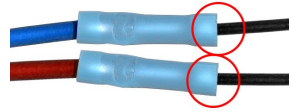

8. Route the horn button wires neatly behind the floor mat and up into the dash area.

9. Locate the (2) spade connectors on the light bar wire harness and connect them to the back of the horn (it doesn't matter which wire goes to which terminal on the horn).

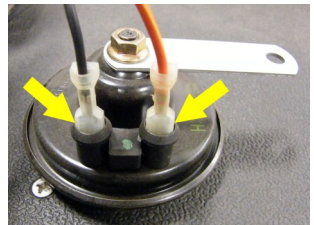

10. Mount the horn to the chassis using the bolt next to the driver side upper shock mount.

**NOTE:** The side of the horn with the wires will face the rear of the cart.

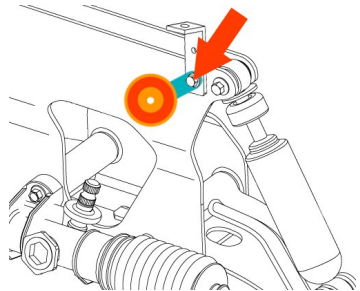

### 12 Volt Receptacle and/or Dual USB Outlet



ACC-0058



ACC-0088



### ACC-0058 12 Volt Receptacle

1. Locate the indentation to the left of the key switch on the dash panel and drill a 1" hole with a hole saw. Sand any rough edges with sandpaper.
2. Mount the 12V receptacle with the Included Hardware to the dash panel.
3. Using a utility knife, carefully remove the protective cover on the 12V receptacle connectors on the LGT-696 sub-harness.
4. Connect the 12V positive lead to the inside, center terminal of the 12V outlet and the 12V negative lead to the outside terminal.

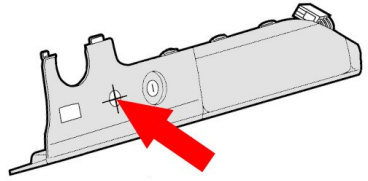

### ACC-0088 Dual USB Outlet

1. Locate the indentation to the left of the key switch on the dash panel and drill a 1-1/2" hole (max. size) with a hole saw.
2. Insert the dual USB outlet and wires through the protective cap into the dash. Secure it with the threaded retaining ring.
3. Using a utility knife, carefully remove the protective cover on the 12V receptacle connectors on the LGT-696 sub-harness.
4. Use a butt connector to connect the red wire on the USB outlet to the blue positive wire on the LGT-696.
5. Use another butt connector to connect the black wire on the USB outlet to the brown (negative) wire on the LGT-696. If needed, cut the wires to the desired length.

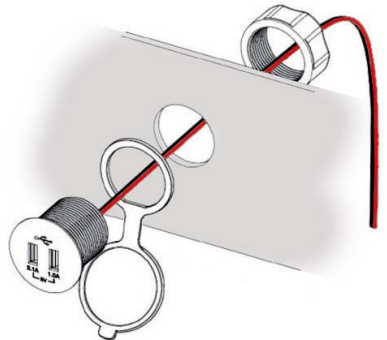
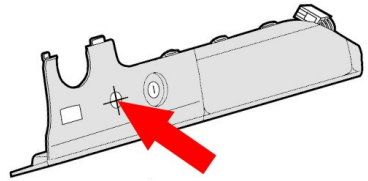

**NOTE:** A fuse holder (ACC-0019) and 15A fuse (ACC-0021) are recommended if direct connecting the USB Ports to a 12V battery, voltage reducer or the accessory connections on the harness.

## Brake Switches



LGT-136



LGT-138



LGT-644

### LGT-138 Brake Light Pad Switch

**NOTE:** The LGT-138 brake pad switch is designed to be used with 12V-DC low amperage power ONLY. If you are installing the LGT-138 into a non-Red Hawk application and running LED taillights, it can be wired directly inline. If you are installing the LGT-138 with incandescent bulbs, you will need to utilize P/N LGT-114, 12V DC relay, or LGT-136, Brake Relay Harness. Running anything more than 12V DC at 0.5 amps through the LGT-138 will damage the brake light switch and void any warranty.

1. Center the LGT-138, brake light pad switch, on the lower portion of the brake pedal assembly and align it with the edges of the pedal.
2. If mounting the switch using the Included Screws, fasten the pad directly to the pedal. If mounting the switch using the Included Rivets, mark the hole locations and drill (6) 3/16" holes through the pedal. Mount the pad with the rivets.

3. Put the brake pedal in PARK. Run the wire from the pad down the pedal to the pedal compartment. Keep it close to the driver side corner so it is not pinched.

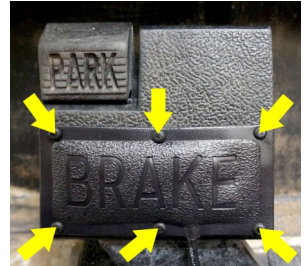

4. Drill (2) holes in the pedal compartment close to the driver side and secure the pad wire out of the way with a wire tie.

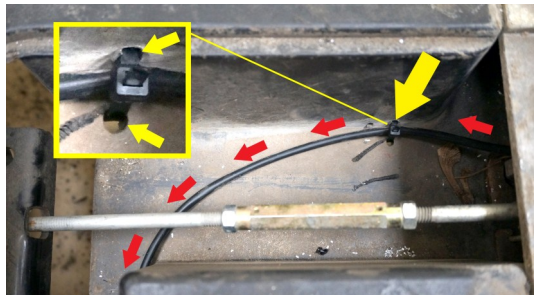
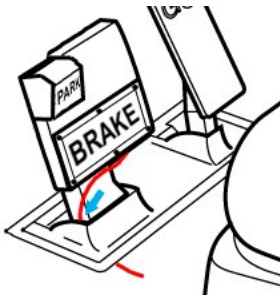

- Connect the brake pad to the LGT-148 adapter and route the wires under the pedal linkage. Connect the remaining wires as shown below.

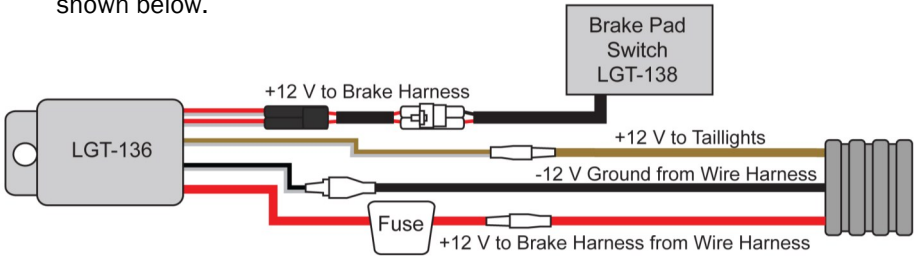

- Drill (2) holes in the pedal compartment for the relay. Secure the relay and the rest of the loose wires with cable ties.
- Reinstall pedal group access cover, floor mat, lower body trim and receptacle cover with Original Hardware.

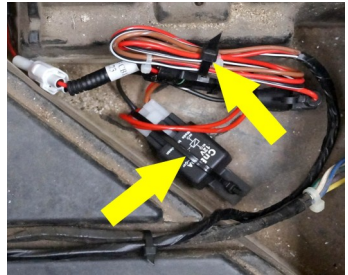

### LGT-644 Brake Light Switch with Time Delay

- Loosen front most nut on the brake rod.
- Slide the brake switch clip upward, between the nut and the rod. Tighten the nut. Disengage the brake pedal.
- Mount the brake switch towards the rear of the pedal compartment with Self Tapping Screws (not included). Position so the spring is tight, but not pulling the plunger. The plunger should move to activate the switch when the brake pedal is engaged. Unscrew the rear portion of the switch if needed for clearance.
- Run the brake switch wires under the brake rod.

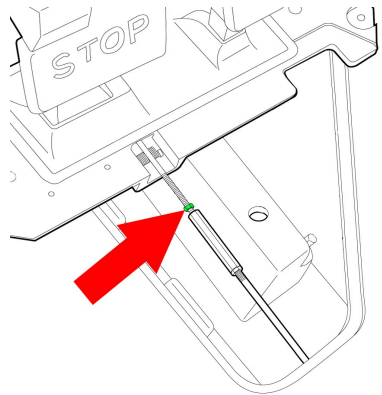

5. Connect the brake switch to the time delay and the bucket harness as shown in the diagram below.

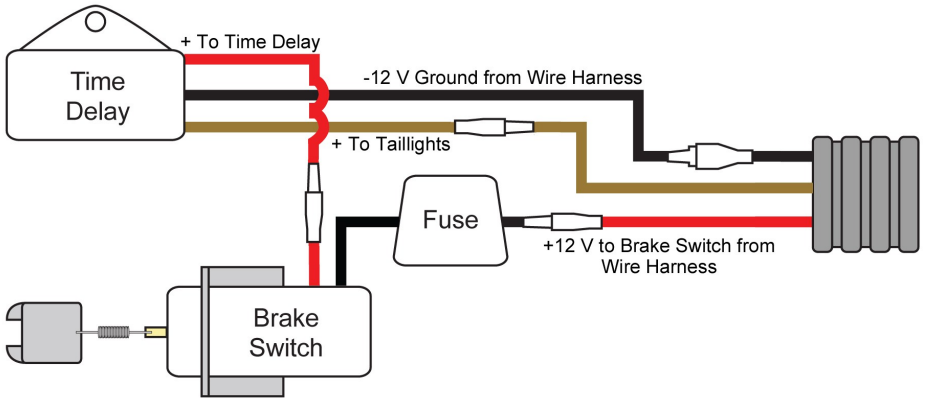

6. Secure the time delay to the right side of the pedal compartment with a self tapping screw or cable ties. Secure all loose wires with cable ties so they are out of the way of the pedal mechanisms.
7. Reinstall the pedal group access cover and floor mat using the Original Hardware.
8. Reinstall the lower body trim with the Original Hardware. Reinstall the receptacle cover.

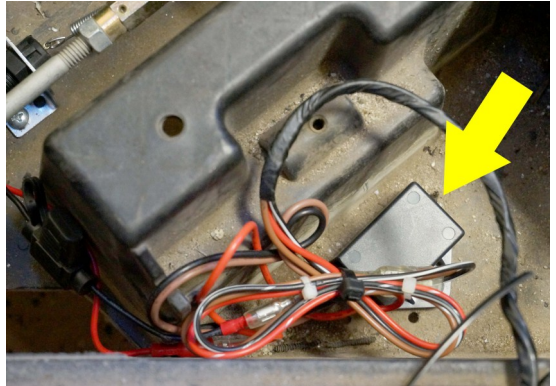

Your Precedent Light Kit is now complete.  
Please enjoy safely!

Watch this installation and others on YouTube:  
[www.youtube.com/user/GolfCartInstructions](http://www.youtube.com/user/GolfCartInstructions)